

Hamilton Safe Lockers

Custom built to your specifications
for superior security



HAMILTON
BY **GUNNEBO**[®]

LOCKERS

Custom built to your specifications for superior security

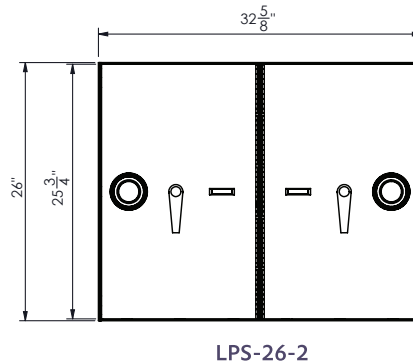
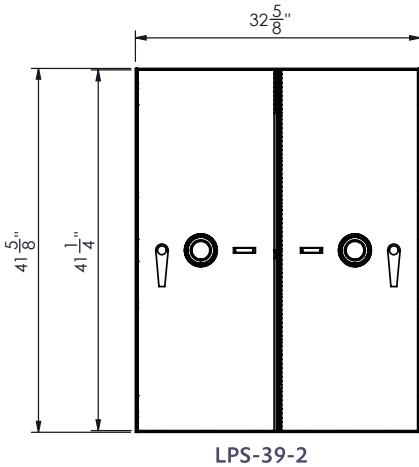
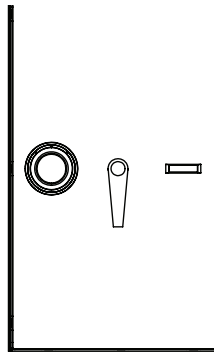
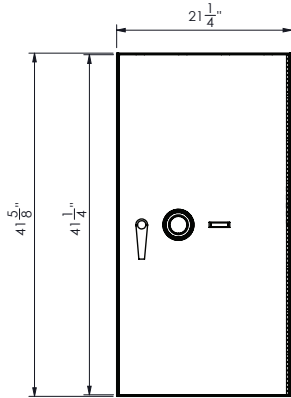
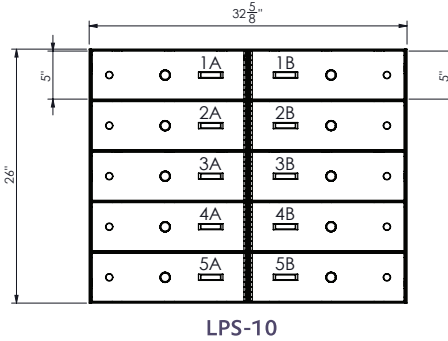
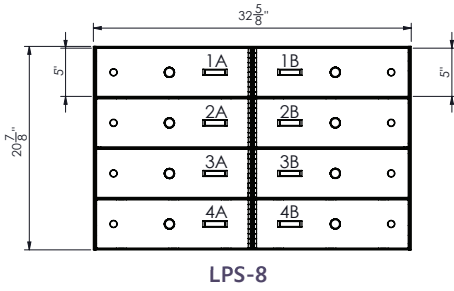
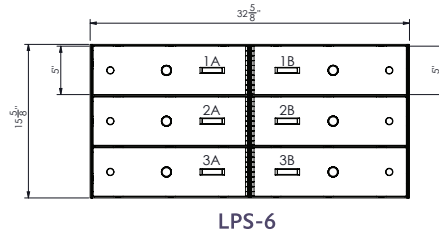
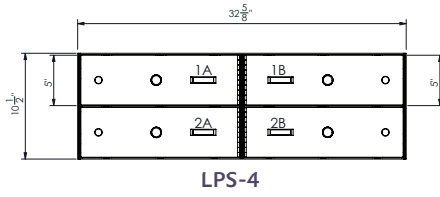

PHYSICAL SECURITY

- CASINGS: SOLID STEEL PAINTED FINISH
- DOORS: 1/4" SOLID STEEL PAINTED FINISH
- HINGES: PIANO HINGES BLACK
- NUMBERING: DECORATOR NUMBER PLATES
- LOCKS: STANDARD U.L. LISTED SAFE DEPOSIT BOX LOCK, EITHER SINGLE OR-DOUBLE NOSE. OPTIONAL MECHANICAL COMBINATION LOCKS, & HIGH SECURITY ELECTRONIC LOCKS
- CUSTOM: CUSTOMER SPECIFIC SIZE AND CONFIGURATIONS
- COLOR: GRAY LEATHERETTE STANDARD
- OPTIONAL COLORS: CHARCOAL GRAY, BLACK LEATHERETTE, INSTRUMENT TAN
- OPTIONAL STAINLESS CLAD DOORS

