

MegaPX MicroDome 2

The **March Networks® MegaPX MicroDome 2** offers best-in-class Wide Dynamic Range (WDR) and 3MP resolution in a dome configuration for indoor and outdoor applications. The camera's exceptional WDR technology captures crystal-clear images in environments with large windows, bright light, and potential glare. Its P-Iris maintains image sharpness, even in varying outdoor lighting conditions, and the remote zoom and focus allow users to adjust the viewing angle over the network — eliminating the need for manual focusing. Multiple H.264 and M-JPEG video streams can be recorded simultaneously.



HD 720P UP TO 3MP RESOLUTION

The MegaPX MicroDome 2 offers high-resolution 3MP video (up to 30 fps) for crystal clear images and phenomenal detail. It is also a high-definition (HD) camera that delivers 720p or 1080p resolution for a sharp display that you can count on.

CLEAR IMAGES IN ALL LIGHTING CONDITIONS

The camera's powerful combination of WDR and True Day/Night (TDN) technology, plus progressive scan in high resolution, ensures excellent image quality, even in bright backlight and extreme low-light conditions. The P-Iris also allows for images with better contrast, clarity, resolution and depth of field.

EASY TO INSTALL; EASY ON YOUR NETWORK

The camera's support for Power over Ethernet (PoE) eliminates the need for additional power cables, making it easy to install and resulting in substantial time and cost savings. Its remote zoom/focus feature means you will never have to adjust focal length and focus settings from the top of a ladder. Instead, you can zoom in on the scene and focus the camera with a simple mouse click. In addition, the camera supports H.264, the most efficient video compression technique available; it yields high video quality and frame rate at low bandwidth.

NEVER LOSE VIDEO

The MegaPX MicroDome 2 can record to an internal microSDXC to ensure redundant recording in the event of a network outage or server failure. When the camera is used with March Networks Command Recording Server, an innovative Shadow Archive™ feature re-integrates the "missing" video and audio in the right spot, for total fail-safe management.

ENGINEERED FOR HARSH ENVIRONMENTS

The MegaPX MicroDome 2 is protected by an IP66, vandal-resistant casing, allowing it to operate in temperatures as low as -40°F (-40°C), and as high as 140°F (60°C). Additionally, the dome's enclosure has an IK10 impact protection rating — one of the highest impact resistance ratings available — which means the internal camera is safeguarded from external strikes. The camera can also alert users if it is redirected, blocked, manipulated or otherwise disturbed.

FEATURES

- HD 3MP resolution (up to 30 fps @ max resolution)
- Best-in-class WDR
- Remote motorized zoom and focus lens
- P-Iris
- Active video tampering
- TDN for superior low-light performance
- Shadow Archiving™ with microSDXC
- Dual-streaming H.264 and M-JPEG
- ONVIF S-compliant for open integration with third-party systems
- Operating temperatures of -40° to 140°F (-40° to 60°C)
- Vandal-resistant, impact-resistant (IK10) and weather-proof (IP66) housing
- Pendant, wall, pole, and corner mounts
- Power over Ethernet (PoE) or 24VAC

PART NUMBERS

DOMES

- 30824 – MegaPX MicroDome 2

MOUNTS

- 30332 – 1.5" NPT mount adaptor with sunshield
- HOMINIDOMESMA – Pendant mount
- HOMINIDOMEWB – Wall mount
- HOMINIDOMEPPMA – Pole adaptor
- 27639 – Corner adaptor

Outstanding Clarity

The MegaPX MicroDome 2 delivers up to 3MP resolution (30 fps @ maximum resolution).



The MegaPX MicroDome 2's high resolution provides greater detail and better possibilities for identification. In addition, the camera can cover larger areas than non-megapixel cameras.



When reviewing live or recorded video, the MegaPX MicroDome 2 allows you to digitally zoom in on a specific area, with no loss of definition, to capture important details such as facial features or a license plate number.

Clear Images in Harsh Lighting

The MegaPX MicroDome 2 offers Wide Dynamic Range (WDR) to overcome the many lighting challenges that can exist in a scene, including intense backlighting, shadows and glare from reflective surfaces such as windows and floors.



WDR Off: *Without WDR, subjects appear silhouetted, details and definition are lost, bright areas are overexposed and dark areas are underexposed.*





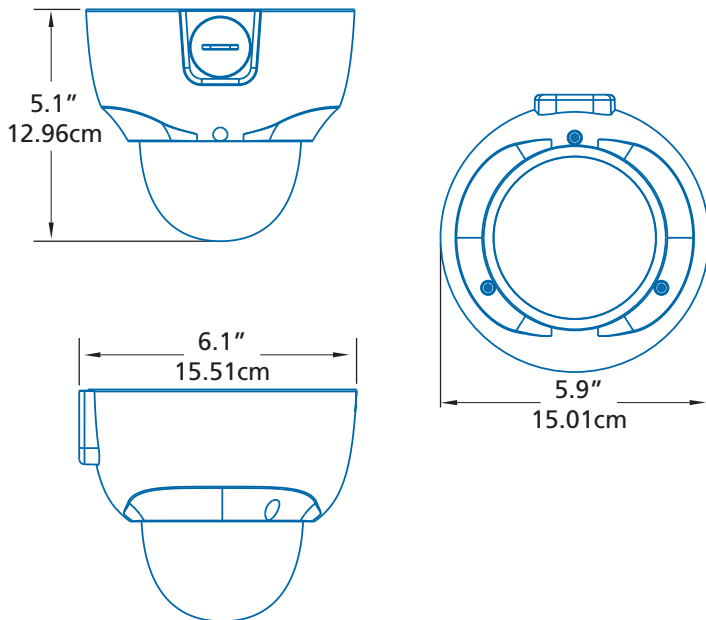
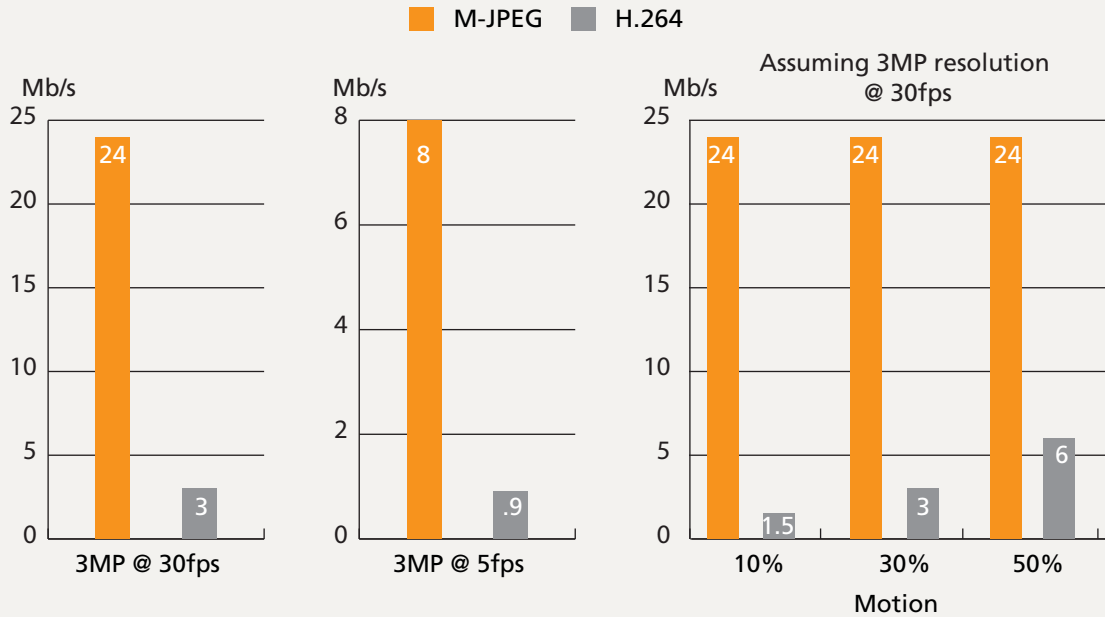

WDR On: *The WDR technology allows the pixels in the bright and dark areas to adjust automatically to eliminate over and under exposure. Color is improved, both in the foreground and in the background. Details are in focus and subjects can be positively identified.*

Our cameras support H.264 compression. The most efficient video compression technique available, H.264 yields full frame rate and high video quality at low bandwidth.



MOUNTING OPTIONS

	Part Number
	30332 1.5" NPT Mount Adaptor with Sunshield
	HOMINIDOMESMA 1.5" NPT Pendant Mount
	HOMINIDOMEWB 1.5" NPT Wall Mount
	HOMINIDOMEPPMA Pole Adaptor
	27639 Corner Adaptor

MegaPX MicroDome 2

CAMERA

Image Sensor	1/2.8" 3MP progressive scan CMOS
Wide Dynamic Range	95 dB
Lens	3–9 mm, F1.2 with motorized zoom/focus, P-iris. Angle of view: 33.5°-83.2° (horizontal)
Minimum Illumination	Color: 1.57 lux B/W: 0.03 lux
Shutter Time	1/25 to 1/1000 sec
Camera Angle Adjustment	Pan 360°, tilt 156°, rotation 360°
Pan/Tilt/Zoom	Optical zoom 3X; digital PTZ via Command
White Balance	Manual/automatic

VIDEO

Video Compression	H.264 (MPEG-4 Part 10/AVC); M-JPEG
Resolution	2048 x 1536 (3MP) to 352 x 288 (CIF)
Frame Rate	Up to 30 fps @ 3MP
Video Streaming	Dual-stream H.264 and M-JPEG (full resolution on stream 1; maximum D1 on stream 2) Controllable frame rate and bandwidth CBR/VBR H.264; VBR M-JPEG (quality settings)
Image Settings	Wide Dynamic Range, anti-flicker, white balance mode, brightness, contrast, saturation, hue, sharpness, auto day-night, mirror mode, privacy patches, 3D noise reduction

AUDIO

Audio Streaming	Two-way stereo
Audio Compression	G.711 PCM G.726 ADPCM Configurable bit rate (8-48 kHz)
Audio Input/Output	Stereo line in; stereo line out

NETWORK

Security	Password protection, IP address filtering, connection management, LDAP authentication, HTTPS encryption (configuration only), 802.1X, smartcard/USB token
Supported Protocols	ONVIF S, RTP, RTSP, RTCP, HTTP, HTTPS, IPv4, TCP, UDP, DHCP, ARP, LDAP, 802.1X
Interface	10/100Mbps Ethernet (RJ-45)
Internet Browser	Internet Explorer (9.0+ Windows only); Google Chrome (Windows only); Safari 5 (Mac OS X 10.6 only)

SYSTEM INTEGRATION

Intelligent Video	Video motion detection, connection monitoring, active tampering
Alarm Triggers	Video motion detection, external input
Alarm Events	External output activation Video recording to local storage microSDXC

GENERAL

Housing	Polycarbonate transparent bubble Aluminum inner camera module with encapsulated electronics IP66, ingress protection IK10, protection rating
Power	Power over Ethernet (PoE) IEEE 802.3af Class 0; 24VAC
Power Consumption	4W (heater off), 12W (heater on)
Connectors	RJ-45 100BASE-TX PoE; 1 alarm input; 1 alarm output; 3.5mm line in; 3.5mm line out
Local Storage	microSDXC memory card slot (card not included)
Operating Conditions	-40° to 140°F / -40° to 60°C
Regulatory Approvals	CE – EMC Directive 2004/108/EC, Standards EN55022, EN55024; Low Voltage Directive 2006/95/EC; FCC Part 15 Subpart B, ICES-003; UL 60950-1; RoHS Directive (2011/65/EU); C-tick, IP66, IK10; WEEE
Mechanical Weight Dimensions (HxD)	2.98 lbs / 1.35 kg 5.1 x 5.9 in. / 12.96 x 15.01 cm
Direct Mounting Options	Surface mount with side and bottom cable access
Indirect Mounting Options (sold separately)	1.5" NPT mount adaptor (with sunshield), pendant mount, wall mount, pole adaptor, corner adaptor
Included Accessories	Software CD (including documentation, browser, and Command applications), screwdriver, screws, wall anchors, mounting template